

Single-Phase Socket SSR With Detachable Heatsink



SRS1 Series CATALOG

For your safety, read and follow the considerations written in the instruction manual, other manuals and Autonics website.

The specifications, dimensions, etc. are subject to change without notice for product improvement. Some models may be discontinued without notice.

Features

- Dielectric strength : 2,500 VAC~
- Rated input voltage
 - SRS1-A: AC, DC, AC / DC
 - SRS1-B: AC
 - SRS1-C: AC, DC, AC / DC
- Socket type for easier installation and maintenance
 - SRS1-A: Autonics SK-G05 sockets
 - SRS1-B: General LY2 sockets
 - SRS1-C: General MY4 sockets
- Zero cross turn-on, random turn-on models available
- Input indicator (red)

Model					
Model	Rated input voltage	Rated input current	Rated load voltage	Connections	Function
SRS1-A1202	4 - 24 VDC≡	2 A	24 - 240 VAC~		Zero cross turn-on
SRS1-A1202R		3 A			Random turn-on
SRS1-A1203					Zero cross turn-on
SRS1-A1203R		5 A	Random turn-on		
SRS1-A1205			Zero cross turn-on		
SRS1-A1205R		Random turn-on			
SRS1-A1D101	4 - 24 VDC≡	1 A	5 - 100 VDC≡		
SRS1-A1D102		2 A	5 - 100 VDC≡		
SRS1-A1D201		1 A	5 - 200 VDC≡		
SRS1-A1X201		1 A	5 - 240 VAC~/ 5 - 200 VDC≡		
SRS1-B1202	4 - 30 VDC≡	2 A (configures to 2-circuit)	90 - 240 VAC~		Zero cross turn-on
SRS1-B1202R-2		Random turn-on			
SRS1-B1203-1		3 A			Zero cross turn-on
SRS1-B1203R-1					Random turn-on
SRS1-B1205-1		5 A			Zero cross turn-on
SRS1-B1205R-1	Random turn-on				
SRS1-C1202-2	4 - 30 VDC≡	2 A (configures to 2-circuit)	90 - 240 VAC~		Zero cross turn-on
SRS1-C1202R-2		Random turn-on			
SRS1-C1203-1		3 A			Zero cross turn-on
SRS1-C1203R-1					Random turn-on
SRS1-C1205-1		5 A			Zero cross turn-on
SRS1-C1205R-1					Random turn-on
SRS1-C1D102-1	4 - 24 VDC≡	2 A	5 - 100 VDC≡		
SRS1-C1X201-1		1 A	5 - 240 VAC~/ 5 - 200 VDC≡		

Specifications

Input

Model	SRS1-A	SRS1-B	SRS1-C120	SRS1-C1
Rated input voltage range	4 - 24 VDC	4 - 30 VDC	4 - 30 VDC	4 - 24 VDC
Allowable input voltage range	4 - 26.4 VDC	4 - 32 VDC	4 - 32 VDC	4 - 26.4 VDC
Max. input current	15 mA (Random turn-on)	13 mA (Random turn-on)	13 mA (Random turn-on)	15 mA
Operating voltage	≥ 4 VDC			
Releasing voltage	≤ 1 VDC			

Output (AC load)

Model	SRS1-A			SRS1-B / SRS1-C		
	1202(R)	1203(R)	1205(R)	1202(R)-2	1203(R)-1	1205(R)-1
Rated input load range	24 - 240 VACrms ~ (50 / 60 Hz)			90 - 240 VACrms ~ (50 / 60 Hz)		
Allowable input load range	24 - 264 VACrms ~ (50 / 60 Hz)			90 - 264 VACrms ~ (50 / 60 Hz)		
Rated load current	2 Arms	3 Arms	5 Arms	2 Arms	3 Arms	5 Arms
Resistive load (AC-51 ⁰¹⁾)	2 Arms	3 Arms	5 Arms	2 Arms	3 Arms	5 Arms
Min. load current	0.15 Arms	0.2 Arms		0.15 Arms		
Max. 1 cycle surge current (60 Hz)	126 A	250 A		126 A		250 A
Max. non-repetitive surge current (I _t , t = 8.3 ms)	65 A ² s	400 A ² s		65 A ² s		220 A ² s
Peak voltage (non-repetitive)	600 V					
Leakage current (Ta = 25 °C)	≤ 2 mArms (240 VAC ~ 50/60 Hz)					
Output ON voltage drop [Vpk] (Max. load current)	≤ 1.6 V					
Static off state dv/dt	500 V/μs					
Operating time	Zero cross turn-on: ≤ 0.5 cycle of load power + 1 ms Random turn-on: ≤ 1 ms					
Releasing time	≤ 0.5 cycle of load power + 1 ms					

01) AC-51 is utilization category at IEC60947-4-3.

Output (DC load)

Model	SRS1-A1D101	SRS1-A1D102	SRS1-A1D201	SRS1-C1D102-1
Rated input load range	5 - 100 VDC		5 - 200 VDC	5 - 100 VDC
Allowable input load range	3 - 120 VDC		3 - 220 VDC	3 - 120 VDC
Rated load current	1 Adc	2 Adc	1 Adc	2 Adc
Resistive load (AC-51 ⁰¹⁾)	1 Adc	2 Adc	1 Adc	2 Adc
Min. load current	10 mA			
Max. surge current (t=10 ms)	5 A	10 A	4 A	10 A
Leakage current (Ta = 25 °C)	≤ 100 μA			
Output ON voltage drop [Vpk] (Max. load current)	≤ 1.1 V			
Static off state dv/dt	500 V/μs			
Operating time	≤ 1 ms	≤ 2 ms	≤ 1 ms	≤ 1 ms
Releasing time	≤ 1 ms			

01) AC-51 is utilization category at IEC60947-4-3.

Output (AC / DC load)

Model	SRS1-A1X201	SRS1-C1X201-1
Rated input load range	5 - 240 VACrms ~ (50 / 60 Hz) / 5 - 200 VDC	
Allowable input load range	3 - 264 VACrms ~ (50 / 60 Hz) / 3 - 220 VDC	
Rated load current	1 Arms / 1 Adc	
Resistive load (AC-51 ⁰¹⁾)	1 Arms / 1 Adc	
Min. load current	10 mA	
Max. surge current (t=10 ms)	4 A	
Leakage current (Ta = 25 °C)	≤ 2 mArms	≤ 2 mArms (240 VAC ~ 50 / 60 Hz)
Output ON voltage drop [Vpk] (Max. load current)	≤ 2.2 V	
Static off state dv/dt	500 V/μs	-
Operating time	≤ 2 ms	
Releasing time	≤ 1 ms	

01) AC-51 is utilization category at IEC60947-4-3.

General specifications

Dielectric strength (Vrms)	Input - output, input / output-case: 2500 VAC ~ 50/60 Hz for 1 min
Insulation resistance	≥ 100 MΩ (500 VDC = megger)
Indicator	Input indicator (red)
Ambient temperature ⁰¹⁾	-20 ~ 80 °C (SRS1-A: -20 ~ 70 °C), storage: -30 ~ 100 °C (no freezing or no condensation)
Ambient humidity	45 ~ 85 %RH, storage: 45 ~ 85 %RH (no freezing or condensation)
Protection	According to protection of the using socket
Approval	CE, TÜV, ENEC

01) Refer to the 'SSR Derating Curve' because the capacity of the rated load current is differ depending on the ambient temperature.

	SRS1-A	SRS1-B	SRS1-C
Weight (packaged) ⁰¹⁾	≤ 3 A: ≈ 17 g (≈ 270 g) 5 A: ≈ 28 g (≈ 380 g)	≈ 30 g (≈ 400 g)	≈ 30 g (≈ 400 g)

01) The weight is per 10 units with packing and the weight of parenthesis is per 1

Dimensions

• Unit: mm, For the detailed drawings, follow the Autonics website.

A Input indicator (red)

SRS1-A

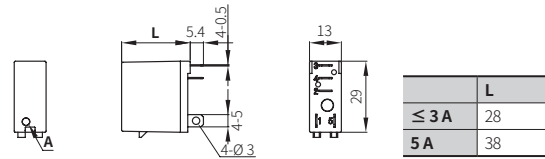

SRS1-B

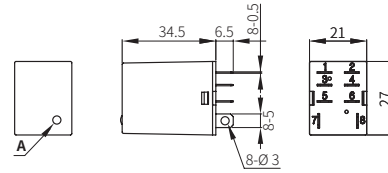

SRS1-C

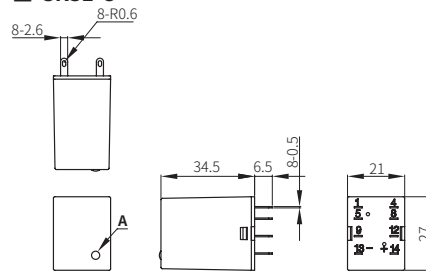

Applied socket

Model	SRS1-A	SRS1-B	SRS1-C
Socket	SK-G05	LY2	MY4
Type	Autonics sockets, Soldered separately	General	General

Sold Separately: SK-G05 (for SRS1-A)

• Unit: mm, For the detailed drawings, follow the Autonics website.
• Protection: IP10

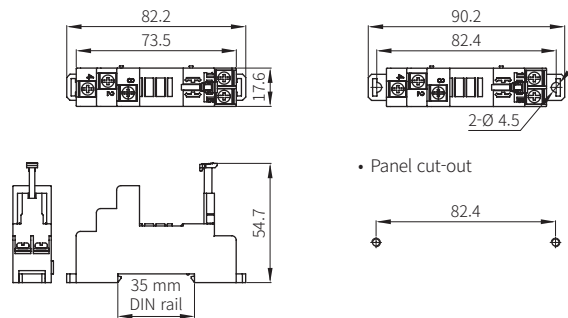

• Panel cut-out

SSR Derating Curve

- Be aware that the ambient temperature and the derating curve is different by the rated input voltage when using the product.
- ⚠ Since the effectiveness of the heat radiation is decreased when SSRs are installed closely, be sure to supply less than 50 % of the rated load current.
- SSR derating curves obtained approval from the UL certification authority.

■ AC load

• SRS1-A

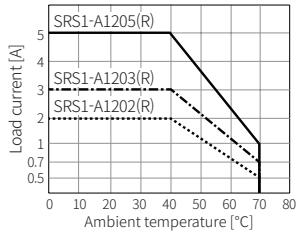

• SRS1-B

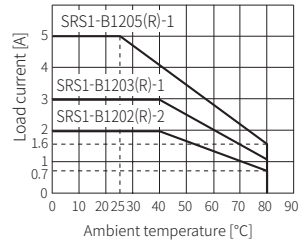

• SRS1-C

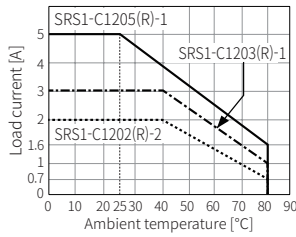

■ DC, AC / DC load

• SRS1-A

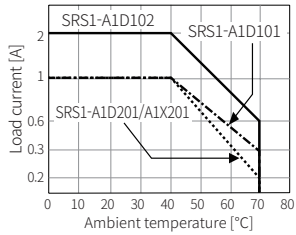

• SRS1-C

